

RCS L-series



This page is intentionally left blank.

Contents

Legal information5
International regulations and conformance6
Supplier’s Declaration of Conformity7
Safety information.8
Overview8
Mechanical safety.9
Electrical and power safety.9
Metric and imperial accessory kits10
Datum ball assembly10
Cleaning the joints10
System overview11
Guidelines for best practice12
Handling the strut.12
Calibration and homing12
RCS L-90 calibration13
Calibration certificates13
Certificate content13
RCS L-90 strut calibration procedure14
Tether use.15
Pillar mounting method.15
Cable positioning prior to volumetric testing.17
RCS Software Suite18
RCS L-90 system contents.19
Hollow ball clamp kit (metric/imperial) contents20

Hollow ball threaded kit (metric/imperial) contents21
Solid ball kit contents22
Part frame kit contents23
Interface LED status24
Calibration troubleshooting25
Equipment mishandling25
In-test robustness25
Further information26

Legal information

Warranty

Unless you and Renishaw have agreed and signed a separate written agreement, the equipment and/or software are sold subject to the Renishaw Standard Terms and Conditions supplied with such equipment and/or software, or available on request from your local Renishaw office.

Renishaw warrants its equipment and software for a limited period (as set out in the Standard Terms and Conditions), provided that they are installed and used exactly as defined in associated Renishaw documentation. You should consult these Standard Terms and Conditions to find out the full details of your warranty.

Equipment and/or software purchased by you from a third-party supplier is subject to separate terms and conditions supplied with such equipment and/or software. You should contact your third-party supplier for details. If you purchased the equipment from any other supplier, you should contact them to find out what repairs are covered by their warranty.

Packing material

Packaging component	Material	94/62/EC Code	94/62/EC number
Outer box	Non-corrugated fibreboard	PAP	21
Bag	Low density Polyethylene	LDPE	4

Renishaw software EULA

Renishaw software is licensed in accordance with the Renishaw licence at:

www.renishaw.com/legal/en/software-licence-agreement

International regulations and conformance

Declaration of conformity



Renishaw plc hereby declares that RCS L-series struts comply with the essential requirements and other relevant provisions of:

- the applicable EU directives
- the relevant statutory instruments under UK law

In compliance with BS EN 61010-1:2010 the product is safe to use in the following environmental conditions:

- Indoor use only
- Altitude up to 2000 m
- Maximum relative humidity (non-condensing) of 80% for temperatures up to 31 °C, decreasing linearly to 50% relative humidity at 40 °C
- Pollution degree 2

The full text of the declaration of conformity is available upon request.

Disposal of waste electrical and electronic equipment



The use of this symbol on Renishaw products and/or accompanying documentation indicates that the product should not be mixed with general household waste upon disposal. It is the responsibility of the end user to dispose of this product at a designated collection point for waste electrical and electronic equipment (WEEE) to enable reuse or recycling. Correct disposal of this product will help to save valuable resources and prevent potential negative effects on the environment. For more information, contact your local waste disposal service or Renishaw distributor.

REACH regulation

Information required by Article 33(1) of Regulation (EC) No 1907/2006 ("REACH") relating to products containing substances of very high concern (SVHCs) is available at:

www.renishaw.com/REACH

FCC

This device complies with part 15 of the FCC Rules. Operation is subject to the following two conditions:

1. This device may not cause harmful interference, and
2. This device must accept any interference received, including interference that may cause undesired operation.

The user is cautioned that any changes or modifications not expressly approved by Renishaw plc or authorised representative could void the user's authority to operate the equipment.

This equipment has been tested and found to comply with the limits for a Class A digital device, pursuant to Part 15 of the FCC rules. These limits are designed to provide reasonable protection against harmful interference when the equipment is operated in a commercial environment. This equipment generates, uses and can radiate radio frequency energy and, if not used in accordance with this user guide, may cause harmful interference to radio communications. Operation of this equipment in a residential area is likely to cause harmful interference, in which case you will be required to correct the interference at your own expense.

Supplier's Declaration of Conformity

47 CFR § 2.1077 Compliance Information

Unique Identifier: RCS L-90 and RCS T-90 systems

Responsible Party – U.S. Contact Information

Renishaw Inc.
1001 Wesemann Drive
West Dundee
Illinois
IL 60118
United States
Telephone number: +1 847 286 9953
Email: usa@renishaw.com

US government notice

NOTICE TO UNITED STATES GOVERNMENT CONTRACT AND PRIME CONTRACT CUSTOMERS.

This software is commercial computer software that has been developed by Renishaw exclusively at private expense. Notwithstanding any other lease or licence agreement that may pertain to, or accompany the delivery of, this computer software, the rights of the United States Government and/or its prime contractors regarding its use, reproduction and disclosure are as set forth in the terms of the contract or subcontract between Renishaw and the United States Government, civilian federal agency or prime contractor respectively. Please consult the applicable contract or subcontract and the software licence incorporated therein, if applicable, to determine your exact rights regarding use, reproduction and/or disclosure.

RoHS compliance

China RoHS



ICES-001 (Canada only)

This ISM device complies with Canadian ICES-001(A) / NMB-001(A).

Cet appareil ISM est conforme à la norme ICES-001(A) / NMB-001(A) du Canada.

Safety information

Overview

The RCS L-series system can be used in a variety of environments and applications.

WARNING: To ensure the safety of the user and other personnel in the vicinity, it is recommended that a comprehensive risk assessment of the robot system under test is carried out before starting.

The risk assessment should be carried out by qualified users (requiring machine competency, application technical knowledge and advice from a trained risk assessor) with consideration for the safety of all personnel. The risks identified must be mitigated prior to using the systems. The risk assessment should pay particular attention to robot system movement (in both manual and automatic modes), manual handling, and electrical safety.

CAUTION: There are no user-serviceable parts inside the RCS L-series robot ballbar and L-series interface modules. Do not remove any part of the housing; to do so could cause personal harm and damage the system irreparably.

Ensure that you have read and fully understood the RCS L-series user guide before using the devices.



CAUTION: The device contains magnets which may cause pinch injuries with metal objects or interfere with electronic and implanted medical devices.

Mechanical safety

When setting up and mounting the RCS L-series, be aware of pinch and/or crush hazards that may be created, for example, due to magnetic coupling and/or the expanding/collapsing of the robot ballbar.

- Be aware of trip hazards that may be created between the cables of the RCS L-series, interface modules and the laptop/desktop computer.
- Exercise caution if either system is mounted to an external axis that moves or rotates. Beware of cables becoming entangled.
- If operating the robot system with guards or any safety features removed or disabled, it is the responsibility of the operator to ensure that alternative safety measures are taken in line with the robot system's operating instructions or relevant codes of practise.
- If operating the robot system within a guarded cell it is the responsibility of the operator to ensure safe practise is followed.
- Any program that is generated should be first verified in manual mode by the operator before running in automatic mode.
- When values in the controller (TCP, part frame, joint offsets) are updated, the production programs should be tested.

Electrical and power safety

- The system must not come into contact with fluids; for example, coolant.
- The RCS L-series must only be powered by the interface modules provided.
- The RCS L-series interface module is compatible with any USB 2.0 port (or above) on a laptop or desktop computer.
- Only use the extension cable and the USB A-Male to B-Male cable provided with the system.
- Never connect the interface modules to devices that are not intended to be used as part of the RCS L-series.

Metric and imperial accessory kits

Both metric and imperial versions of the accessory kits are available. The measurement unit is detailed in the product names. The RCS L-90 kit (Renishaw part no. A-6827-6100) is supplied with metric components and users should ensure they have the correct accessories prior to set-up.

Datum ball assembly

Prior to use, users should ensure all datum balls are clean and undamaged. Where required, use the supplied Renishaw cleaning kit to ensure that kinematic joints are clean and free from debris prior to use.

Cleaning the joints

Prior to mounting the device, ensure all contact points are free from debris (for example, metal shavings on either magnetic mounting interface) using the Renishaw-supplied cleaning kit.

With clean hands, tear off a small piece of material and shape it into a ball.

Press into or onto each feature, taking care to ensure none of the cleaning material is left behind.



System overview

The RCS L-series is a linear ballbar system designed to simplify and enhance the installation and calibration of robot systems. The system can perform a variety of tests, including the calibration of the tool centre point (TCP) and work frames part, volumetric verification, and joint offset calibration.

The RCS L-series strut is magnetically seated between two datum balls; one mounted to the robot end-effector, and the other on a pillar attached to the floor, or a stable surface. As the robot manipulator moves from one position to another, the device records a linear measurement at each position which is then computed inside the RCS Software Suite and output as a result.

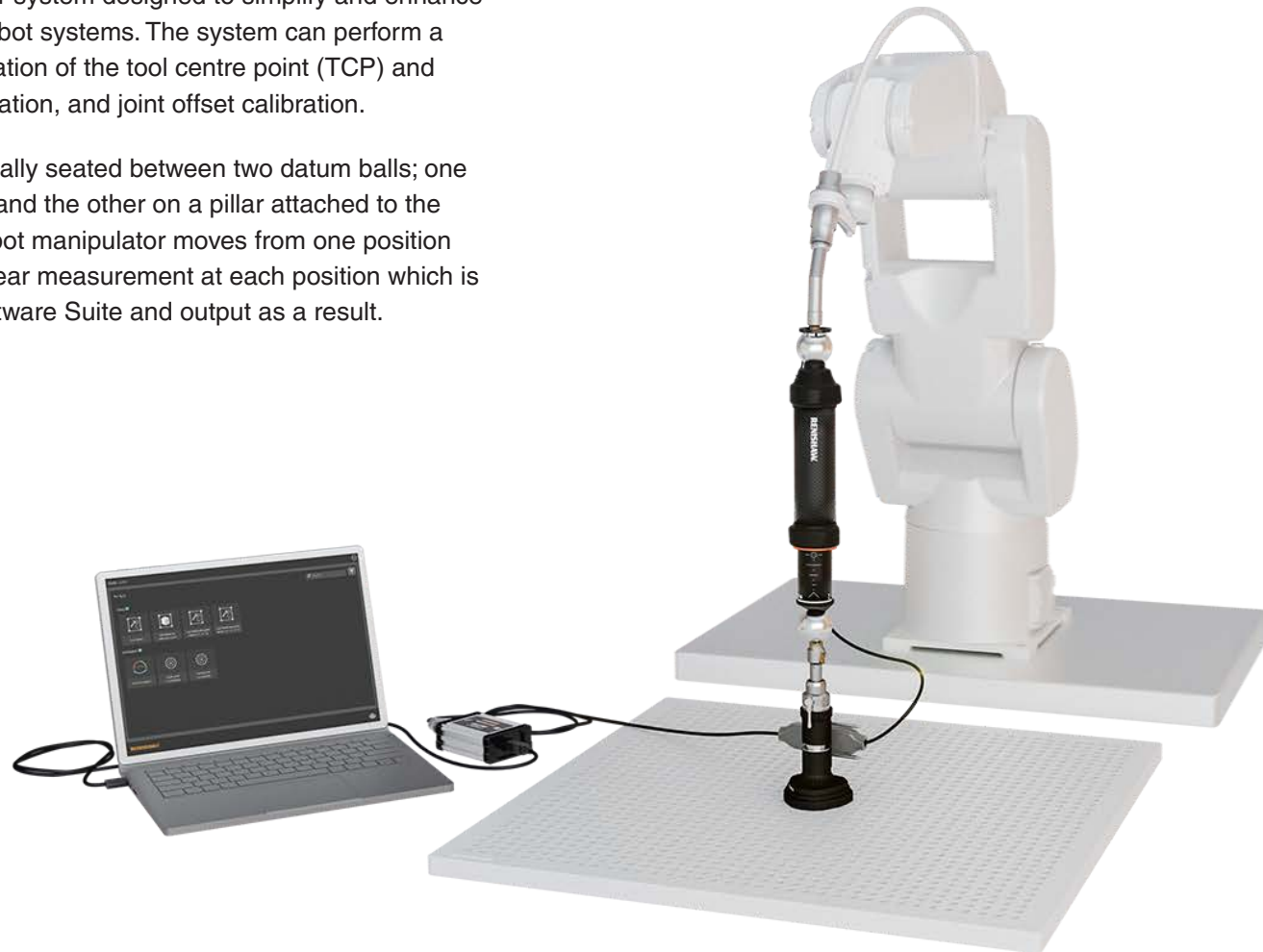

Guidelines for best practice

Handling the strut

The RCS L-series has been designed to be robust, however the equipment is a precision measurement system and must be handled with care. The RCS L-90 device contains an encoder and scale to deliver accurate measurements.

Rough handling of the device may damage it and cause the encoder to malfunction, leading to the need for re-homing. When handling, ensure the device is fully closed wherever possible.

When extending or closing the device, users should ensure that the thumb tag, located on the extending end of the strut, is utilised.



Calibration and homing

Calibration of the RCS L-series system must only be completed with the supplied calibration device.

For best results, it is recommended that the system is calibrated following any notable changes in room temperature. This could be:

- Once every 12 hours
- Before first use in each new location

CAUTION: Handle the calibrator with care. The calibrator is designed to remain in its protective foam tray during use. Removal from the tray is not recommended, but if deemed necessary, handle the unit with care.

The RCS L-90 device is automatically homed when it passes over a reference mark.



RCS L-90 calibration

Calibration certificates

Each RCS L-90 strut and calibrator are delivered with a calibration certificate. This demonstrates that the system has been calibrated at the Renishaw factory with traceability to National Standards. It is proof of the equipment's performance as tested prior to delivery. Visit the **Calibration product quality and conformance** webpage (<https://www.renishaw.com/en/calibration-product-quality-and-conformance--6872>) for more information.

The certificates are important documents which may be required to demonstrate compliance with quality assurance requirements.

Duplicate documents can be supplied, but there is a charge for a hard copy.



Certificate content

Each certificate is unique and is identified by a certificate number. All RCS L-90 strut certificates provide the following key information:

- Serial number of calibrated RCS L-90 device
- Specific test results
- Statement of accuracy
- Traceability data (calibration details)
- Test conditions and methodology

To enable traceability, details of the test equipment used are given. The date of testing and the date of printing the certificate are separately noted and the results are signed by an authorised Renishaw employee.

Details of the test procedure, test environment, and applicable standards, all in accordance with the requirements of Renishaw's ISO 9001 quality assurance system, are also supplied.

RCS L-90 strut calibration procedure

The instructions below ensure best practice is followed when fitting the RCS L-90 strut to the calibrator.

1. With the device closed, carefully attach the extending end (with the cable and thumb tag) of the L-90 strut to one end of the calibrator.



2. Extend the device so that the opposite end of the strut reaches the opposite ball surface of the calibrator. Ensure the RCS L-90 strut is magnetically attached to the calibrator.



3. For removal, the process must be reversed. Close the device by retracting the 'non-cable end', before removing from the calibrator.



Tether use

To protect the device in the event of an unintentional detachment, use of the supplied RCS L-series tether is recommended to connect the RCS L-90 securely to the robot tip and prevent accidental drops.

The tether must be hooked behind the RCS datum ball on the robot and attached to the RCS L-series struts as illustrated below:

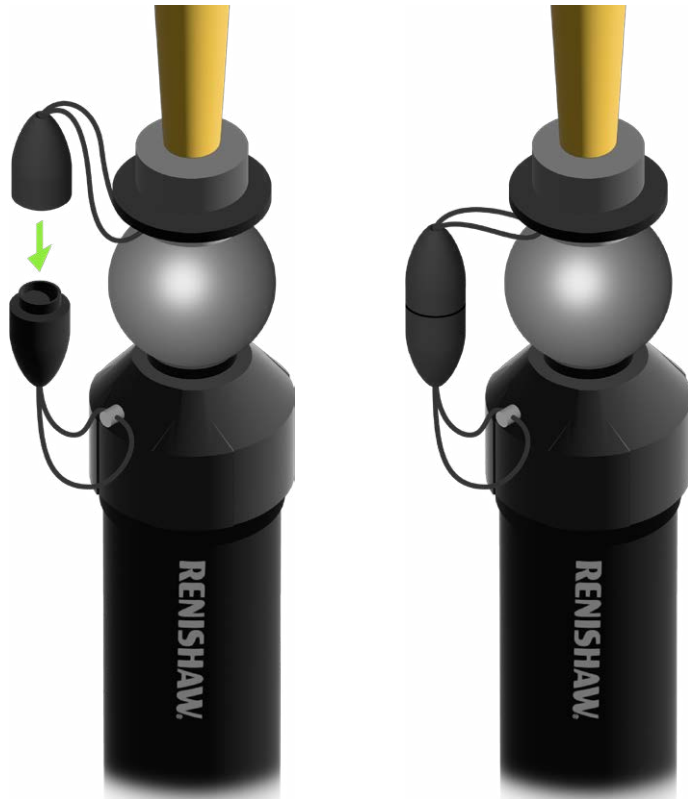

Pillar mounting method

The RCS L-series central pillar can be magnetically mounted to the steel bed of a robot installation, or onto a threaded fixture plate. M6 – M10 bolt options are supported, as well as the imperial equivalents of 5/16 in – 1/2 in.

NOTE: Metric bolts are supplied, imperial bolts are not.

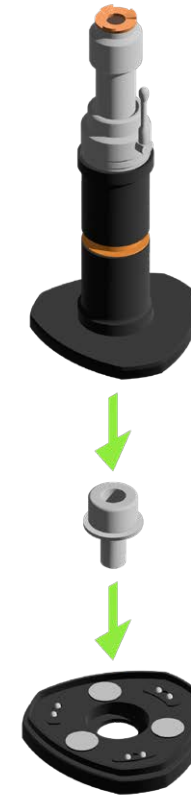

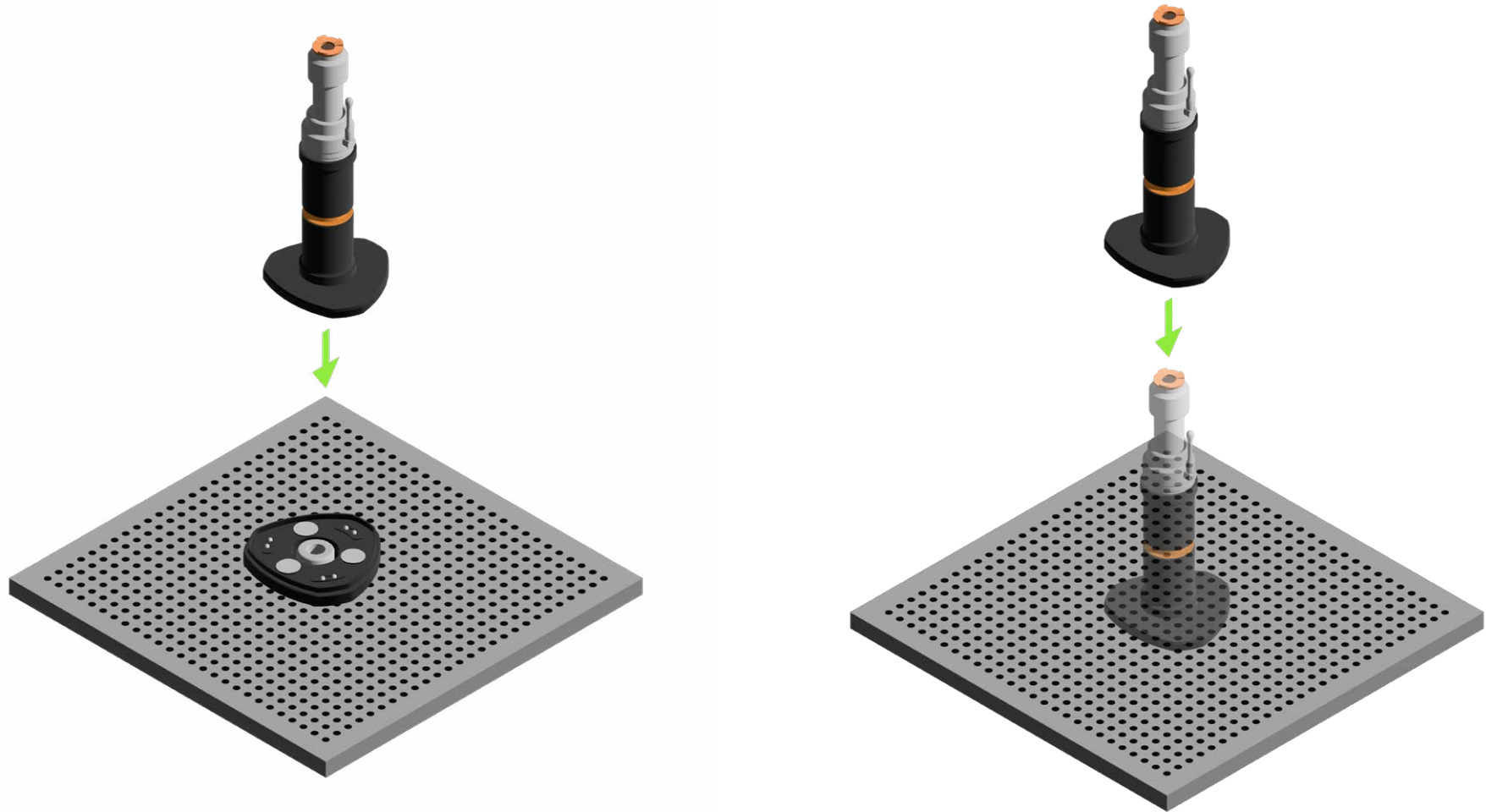

Cable positioning prior to volumetric testing

When undertaking a volumetric test, it is essential to ensure the cable makes a clean 180° loop from the L-90 strut in the starting position to a correctly mounted cable clip as illustrated below. Failure to do so may lead to snagging of the cable and damage to the equipment.

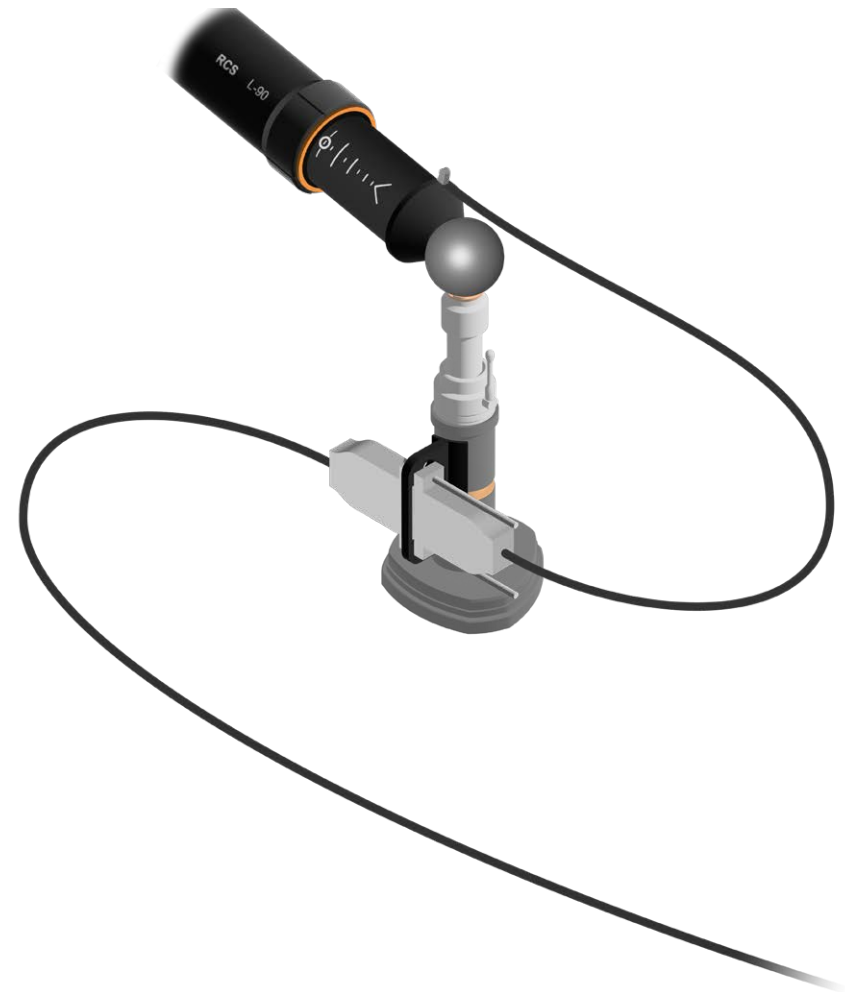

RCS Software Suite

Software download

Before you start

The user will receive an email with their unique licence details from Renishaw Licensing (**licensing@Renishaw.com**). This email contains the user's 'Entitlement ID' which is required for the licence activation process.

Software download

Visit **<https://www.renishaw.com/softwarelicensing>**

If you already have a My Renishaw account, select the 'Sign in' option. It is important that this step is undertaken first.

Sign in | Create an account

- Scroll down to 'Robotics' and click to download the RCS Software Suite.

- If you do not have a My Renishaw account, select 'Create an account'.

Sign in | **Create an account**

- Follow the on-screen instructions to create your account. Your account may take up to three business days to be activated.
- Scroll down to 'Robotics' and download the RCS Software Suite.
- In the event that the drop-down 'Robotics' is not displayed, contact **IAPDsales@renishaw.com**.
- For more information on licensing, visit **Licensing user guides (renishaw.com)**.

RCS L-90 system contents

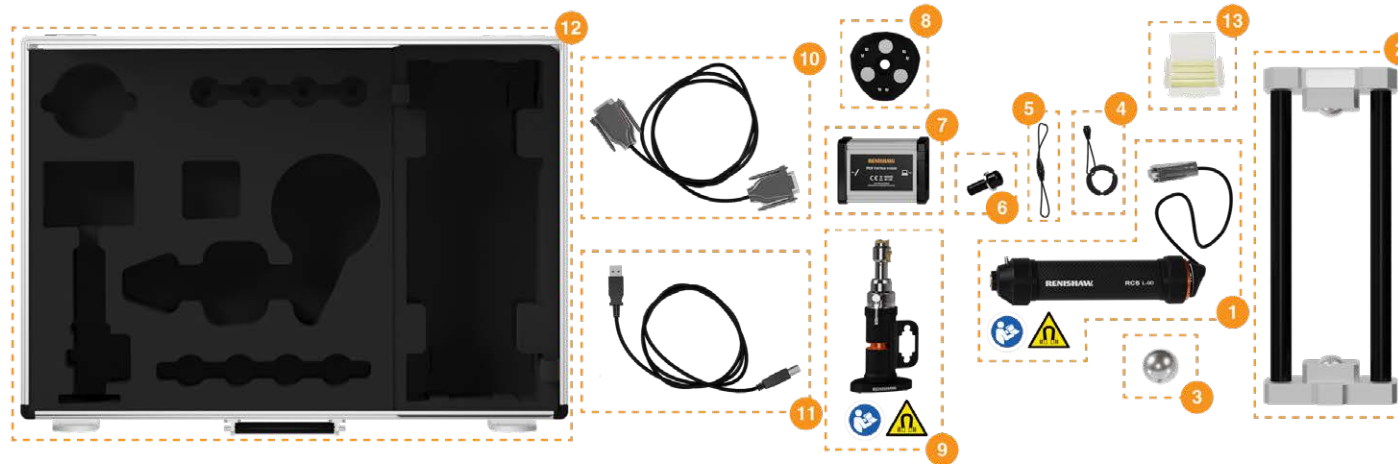

	Part number	Part name
	A-6827-6100	RCS L-90 kit
1	A-6827-6210	RCS L-90 strut
2	A-6827-6230	RCS L-90 calibrator
3	A-6827-1075	RCS datum ball (D-PB35)
4	N/A	RCS tether ring
5	N/A	RCS spare tethers
6	N/A	M6, M8 and M10 bolts
7	A-6827-6240	RCS L interface module
8	A-6827-6250	RCS base mount
9	A-6827-6220	RCS L central pillar
10	N/A	RCS L-15D extension cable
11	N/A	RCS L-USB cable
12	N/A	RCS L-90 case
13	A-1085-0016	Cleaning kit

NOTE: For details of purchasing replacement parts, contact your local Renishaw representative.



CAUTION: Items identified by this warning label contain magnets and may cause pinch injuries with metal objects or interfere with electronic and implanted medical devices.

Hollow ball clamp kit (metric/imperial) contents

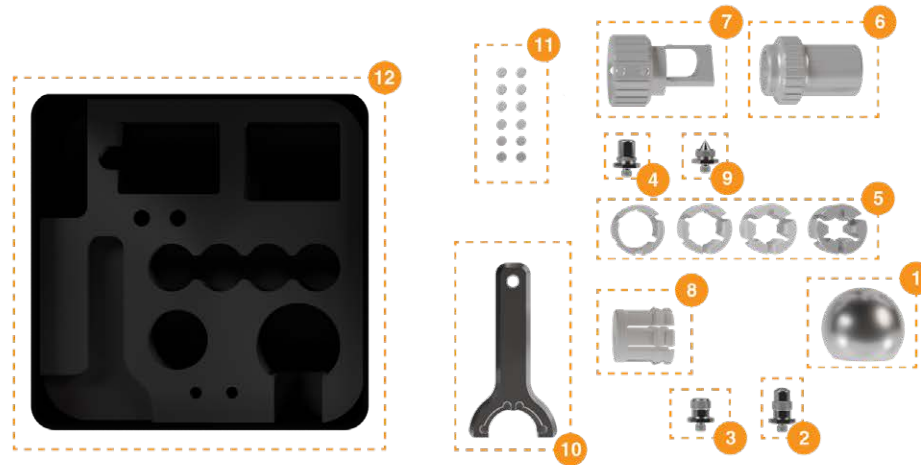

	Part number	Part name
	A-6827-6110	RCS hollow ball clamp kit (metric)
	A-6827-6120	RCS hollow ball clamp kit (imperial)
1	N/A	RCS D-HB35 (hollow ball)
2	N/A	TCP setting screw
3	N/A	TCP setting screw – flat
4	N/A	Universal setting screw cup
5	N/A	TCP clamp adaptors – 20 to 16, 20 to 14, 20 to 12 and 20 to 10 (metric)
5	N/A	TCP clamp adaptors – 3/4 in to 5/8 in, 3/4 in to 9/16 in, 3/4 in to 1/2 in and 3/4 in to 3/8 in (imperial)
6	N/A	RCS hollow ball tool
7	N/A	Universal clamp
8	N/A	TCP clamp
9	N/A	Universal setting screw point
10	N/A	TCP clamp tool
11	N/A	Grub screws (× 12)
12	N/A	Hollow ball kit case

NOTE: For details of purchasing replacement parts, contact your local Renishaw representative.

Hollow ball threaded kit (metric/imperial) contents



	Part number	Part name
	A-6827-6160	RCS hollow ball threaded kit (metric)
	A-6827-6170	RCS hollow ball threaded kit (imperial)
1	N/A	RCS D-HB35 (hollow ball)
2	N/A	Hollow ball adaptors – M6, M8, M10 and M12 (metric)
2	N/A	Hollow ball adaptors – 1/4 in, 5/16 in, 3/8 in and 1/2 in (imperial)
3	N/A	Hollow ball 50 mm extension
4	N/A	Hollow ball tool
5	N/A	Hollow ball threaded kit case

NOTE: For details of purchasing replacement parts, contact your local Renishaw representative.

Solid ball kit contents

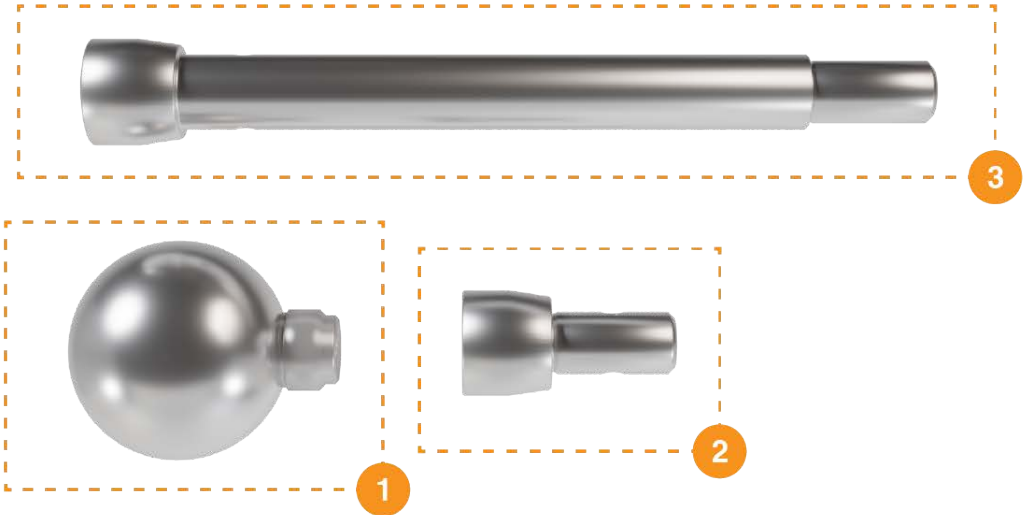

	Part number	Part name
	A-6827-6130	RCS D-SB35 kit
1	N/A	RCS D-SB35
2	N/A	Short connection rod
3	N/A	Long connection rod

NOTE: For details of purchasing replacement parts, contact your local Renishaw representative



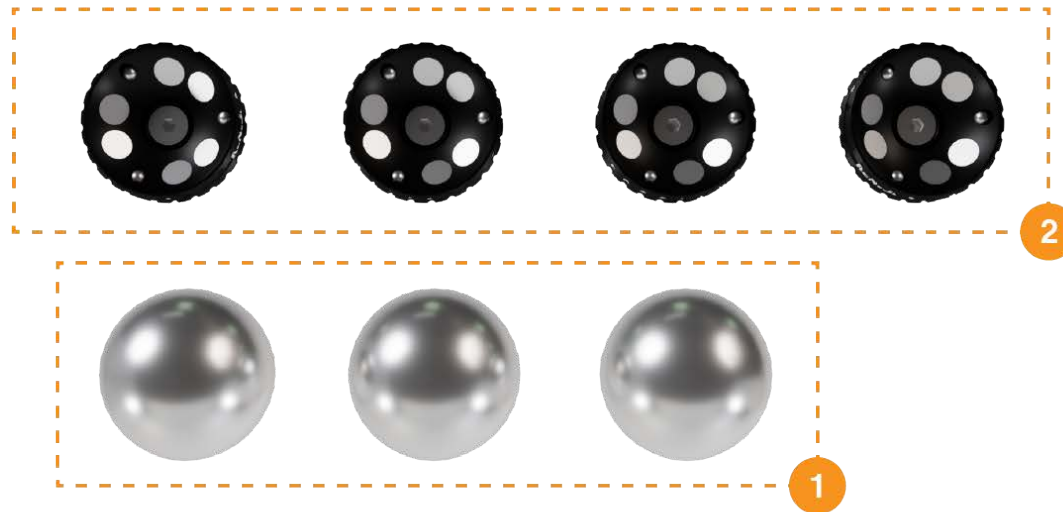





Part frame kit contents



	Part number	Part name
	A-6827-6150	RCS part frame kit
1	N/A	RCS D-PB35 (× 3)
2	N/A	RCS L-BM20 (× 4)
NOTE: For details of purchasing replacement parts, contact your local Renishaw representative		

Interface LED status

On the right panel of the RCS L-series interface is a single LED. When the system is powered on this will display red for 10 seconds during boot mode. See the table below for status/indication:

LED status		Description	Actions
Flashes 3 colours once		Start standard mode.	N/A
Red		Error (unseated strut, detached strut, invalid encoder reading, or invalid encoder signal).	Follow the guidelines on the user interface application to clear the error.
Orange		Requires homing (API connected, no errors).	Start streaming; extend and collapse the strut to find the reference mark.
Cyan		API not connected.	Start the user interface application and connect to the device.
Cyan flashing		No activity on the USB endpoints.	Ensure the user interface application is connected and running normally, and that the USB cable is not damaged and plugged in fully on both ends. Ensure the HID device is listed on the device manager (unplug and plug back in the USB cable if necessary).
Blue		Ready (API connected, no errors, homed).	N/A
Green		Streaming.	N/A
Blink		Received a command from the API (except for streaming commands).	N/A

Calibration troubleshooting

Equipment mishandling

The RCS L-90 will require recalibration using the calibrator if it is dropped or mishandled, particularly if the end joints have been exposed to shock loading.



IMPORTANT: Any automated (robot-driven) compression beyond the RCS L-90 strut minimum length will require the offset to be recalibrated with the calibrator.

In-test robustness

The device has been designed to remain in contact with the datum balls during the specified tests. If the strut detaches from the datum balls during the test process, first check to ensure that the datum balls are undamaged and clean. If this does not resolve the issue, consider reducing the acceleration of the robot.



Further information

For further operational information, refer to the user guides supplied within the RCS Software Suite.

This page is intentionally left blank.

www.renishaw.com/contact

 #renishaw

 +44 (0) 1453 524524  uk@renishaw.com

© 2021–2022 Renishaw plc. All rights reserved. This document may not be copied or reproduced in whole or in part, or transferred to any other media or language by any means, without the prior written permission of Renishaw.
RENISHAW® and the probe symbol are registered trade marks of Renishaw plc. Renishaw product names, designations and the mark 'apply innovation' are trade marks of Renishaw plc or its subsidiaries. Other brand, product or company names are trade marks of their respective owners. Renishaw plc. Registered in England and Wales. Company no: 1106260. Registered office: New Mills, Wotton-under-Edge, Glos, GL12 8JR, UK.

WHILE CONSIDERABLE EFFORT WAS MADE TO VERIFY THE ACCURACY OF THIS DOCUMENT AT PUBLICATION, ALL WARRANTIES, CONDITIONS, REPRESENTATIONS AND LIABILITY, HOWSOEVER ARISING, ARE EXCLUDED TO THE EXTENT PERMITTED BY LAW. RENISHAW RESERVES THE RIGHT TO MAKE CHANGES TO THIS DOCUMENT AND TO THE EQUIPMENT, AND/OR SOFTWARE AND THE SPECIFICATION DESCRIBED HEREIN WITHOUT OBLIGATION TO PROVIDE NOTICE OF SUCH CHANGES.

Part no.: H-6827-8004-01-A
Issued: 12.2022